

Standard PDI-G 101 Revised 2007

**Testing and Rating Procedure
for
Type 1 Hydro Mechanical
Grease Interceptors
with
Appendix of Installation
and
Maintenance**



THE PLUMBING AND DRAINAGE INSTITUTE

Phone: (800) 589-8956

Web: www.pdionline.org

E-mail: pdi@pdionline.org

FOREWORD

The Plumbing and Drainage Institute is comprised of a group of member organizations, each of which is engaged in the manufacture of products for the plumbing industry. The basic aim of PDI is to contribute its combined talents and resources to the further advancement of plumbing engineering and the plumbing industry. This standard is dedicated to those goals.

For nearly a hundred years, grease interceptors have been used in plumbing waste water systems to permit free flow of drainage from sinks and similar equipment and to prevent grease accumulations from clogging connecting piping and sewer lines. In 1883, one Nathaniel T. Whiting of California applied for a patent on a grease trap, which was issued in October of 1884. Whiting's design principle was not unlike that of present day grease interceptors.

For the following fifty years, there were no coordinated efforts to standardize ratings or to establish performance requirements for grease interceptors. Ratings were determined by each manufacturer for its interceptors which were produced in a variety of sizes and types in effort to meet engineer's specifications and satisfy code requirements.

In late 1940 and early 1941, prior to the United States' entry into World War II, grease interceptors were specified for Army posts to meet specifications of the Construction Division, Office of the Quartermaster General. These specifications called for interceptors which proved inadequate; thus it immediately became apparent that a comprehensive engineering and testing program was required in order to properly rate grease interceptors. Apart from prevention of sewage systems clogging, properly rated and sized grease interceptors were essential to the recovery of oils and grease so badly needed for the war effort. As a result, a series of conferences involving the Research Committee of the Plumbing and Drainage Manufacturer's Association (now Plumbing and Drainage Institute), representatives of the Quartermaster General, Surgeon General, Army Corps of Engineers, and others were held to develop a testing program to establish flow rates and grease holding capacity for uniform rating of grease interceptors manufactured at that time. The program that emerged from these conferences included exhaustive laboratory testing of each grease interceptor at the Iowa Institute of Hydraulic Research at the State University. This phase of the program was covered in a comprehensive report issued in August of 1945.

Using the guidelines established in Iowa, the Research Committee continued the testing program at The United States Testing Company, Inc., which culminated with the first issue of this standard in 1949 and certification of applicable grease interceptors.

Since its publication, Standard PDI-G101 has been widely recognized; it is referenced in most plumbing codes and it is included as the basic testing and rating requirement of Military Specification MIL-T-18361.

Grease interceptors specified by engineers are deemed to be acceptable products when they meet the requirements of this standard.

Historically there have been two types of Grease Interceptors. The first type (covered by PDI G101) is normally installed inside a building. They are compact in size because grease separation occurs quickly (about one minute) due to several simultaneous actions; a hydraulic flow action, air entrainment and the difference in specific gravity between water and FOG (fats, oils and grease). This type is now recognized as TYPE I, Hydro Mechanical Grease Interceptors. The second type of grease interceptor must be large (usually installed outside underground) because it requires an extended time for grease separation (30 minutes or more). The separation is simply due to the specific gravity difference between FOG (fats, oils, and grease) and water. This type is now recognized as TYPE II, Gravity Grease Interceptors. Standard G101 performance testing has always applied to only grease interceptors now known as TYPE I Hydro Mechanical Grease interceptors.

Standard PDI-G101 has been updated several times over the years. Now, with this reprint, the standard has been expanded to include two larger capacity grease interceptors, 75 GPM & 100 GPM. The appendix covers valuable installation and maintenance data which the Institute feels will be helpful to the industry. The standard now includes guidance for sizing grease interceptors when the final details of a build out are not known. This sizing criteria is based on the maximum flow that specific drain line sizes can carry. This sizing method is also applicable where changes of occupancy are anticipated.

The Plumbing and Drainage Institute currently maintains a grease interceptor testing, rating and certification facility, for interceptors falling within the scope of this standard.

Manufacturers interested in having interceptors tested, rated, and certified in conformance with Standard PDI-G101 may obtain the details by contacting the Executive Director of the Institute at PDI @ PDIONLINE .ORG

This Standard is not intended to be limiting in any way, but rather is intended to provide a uniform measure of performance by Grease Interceptors. The use of this Standard is voluntary and the issuance or existence of this Standard does not in any respect prevent or restrict any member or non-member of The Plumbing and Drainage Institute from manufacturing or supplying products that do not meet the performance criteria contained in the Standard. The data in this publication are based on information believed to be reliable and are offered in good faith but without guarantee. The Plumbing and Drainage Institute and its member companies assume no responsibility or liability for the use of this Standard. No warranty, express or implied, is made of the information contained in this Standard by The Plumbing and Drainage Institute or by any of its member companies.



TABLE OF CONTENTS

SCOPE	4	Ratio of Lard to Water	11
PURPOSE	4	Test Increments	11
BASIC TEST METHOD	4	Flow Rate	11
CONSTRUCTION of TEST EQUIPMENT	5	Efficiency Determinations	11
Test Sinks	5	Duration of the Test	11
Sink Waste Connections.....	5	Determination of Test Breakdown Point.....	11
Water Level Gauges	5	Requirements for Certification and	
Movable Sink Partitions	5	Factor of Safety	12
Skimming Tank	5	CERTIFICATION CAPACITIES	12
INSTALLATION OF TESTING EQUIPMENT ..	6	SIZING FOR GREASE INTERCEPTORS	13
Sink Location	6	Sizing Considerations	13
Interceptor Location	6	Sizing Symbols	13
Skimming Tank Location	6	Sizing Procedures.....	14
Installation of Waste Piping	6	Dishwashers	15
Sink Connections.....	6	Multiple Fixtures.....	15
Combined Horizontal Waste Piping.....	6	GREASE INTERCEPTOR CERTIFICATE	
Flow Control Devices.....	6	AND CERTIFICATION SEAL	16
Vertical Waste Riser.....	6	Certificate.....	16
Interceptor Discharge Connection	6	PDI Certification Seal	16
Interceptor Inlet Connection.....	6	Marking.....	16
Figure 1 Installation of Testing Equipment.....	7	INSTALLATION	17
PRELIMINARY TEST PROCEDURES	8	Installation Considerations.....	17
Media Analysis.....	8	Flow Control	17
Establishing Sink Compartment Capacity	8	Venting.....	17
Establishing Volume of Incremental Discharge	8	Multiple Fixture Installation	17
Computation of Flow Rate	8	APPENDIX	
Check Flow Rate Tests	8	INSTALLATION DIAGRAMS	18
Calibrated Drainage Flow Rate	9	MAINTENANCE	19
SKIMMING PROCEDURE	10	General Considerations	19
CERTIFICATION TEST PROCEDURE	11	Cleaning	19
Test Media.....	11	Disposition of Intercepted Materials	19



SCOPE AND PURPOSE

1.1 Purpose

Realizing the serious need of a standard procedure for the testing and rating of grease intercepting equipment the Plumbing and Drainage Institute authorized its Research Committee to take the necessary steps to develop such a set of standards. This project would include the design and construction of the testing equipment, preliminary research and testing, the development of a certification test procedure and the development of a standard method of rating the flow capacities and grease retention capacities of grease interceptors.

1.2 Scope

The scope of PDI is to provide a reasonable sizing method expressed as GPM flow, capacity retention in pounds (lbs) and test protocol for sizing and testing the grease interceptor to known proven test requirements. The PDI certified grease interceptors are designed for grease laden waste only. No fixtures that carry sanitary waste are to drain into a grease interceptor.

BASIC TEST METHOD

2.1 The Plumbing and Drainage Institute Standard Testing Procedure for Grease Interceptors is designed to simulate an actual plumbing installation in which the interceptor is subjected to severe operational conditions.

2.2 The test is based on the use of a variable capacity double compartment sink installed on a floor level which is ten (10) feet (3.05m) above the bottom of the interceptor. The sink is connected to the interceptor by means of two (2) inch waste piping. A vented flow control or equal device is installed at the top of the waste riser between the sink and the interceptor. The effluent from the interceptor discharges into a skimming tank, the top of which is located below the outlet of the interceptor. Complete details on the design of the testing equipment and its installation, and the test procedure are outlined hereinafter.

CONSTRUCTION OF TEST EQUIPMENT

3.1 Test Sinks

The sink used in the tests for 4 GPM/50 GPM sizes shall have the following inside dimensions: eight (8) feet (2.44m) in length; two (2) feet (0.80m) in width; twelve and one-half (12 ½) inches (0.32m) in depth and shall be divided into two (2) equal length compartments. The sink for 75 GPM/100 GPM size shall have the following dimensions: one hundred twenty eight (128) inches (3.25m) in length; thirty six (36) inches (1.20m) in width; twelve and one-half (12 ½) inches (0.32m) in depth and shall be divided into two (2) equal compartments. The sink shall be constructed of stainless steel sheet metal. The sink shall have steel angle rim, reinforcement, and legs. The legs shall be of proper length so that the rim of the sink will be three (3) feet (0.91 m) above the floor. The sink legs shall be braced with steel angles or flat bars.

3.1.1 Sink Waste Connections

Each sink compartment for the 4 GPM/50 GPM size is to be fitted with a one and one-half (1½) inch (38mm) standard sink waste connection and the 75 GPM/100 GPM size shall be two (2) inch (50mm), with flange, threaded or slip joint tailpiece and locknut. The waste connections are to be located on opposite sides of the center partition in the corner formed by the side of the sink and the center partition.

3.1.2 Water Level Gauges

Each compartment shall be equipped with a gauge connection and a water level gauge with gauge glass. Each gauge connection shall be fitted into the bottom of a sink compartment and in close proximity to the waste outlet. Each gauge shall be mounted on the outside of the sink, adjacent to its respective gauge connection, and shall extend diagonally upward from the bottom center to the top outside corners. These gauges shall be calibrated to read directly the number of inches of water in the sink compartments above the sink waste flange.

3.1.3 Movable Sink Partitions

Each compartment of the sink shall be fitted with a movable partition, making it possible to regulate the size of the compartment to any desired capacity.

3.2 Skimming Tank

The skimming tank is to be rectangular in shape, open at the top and equipped with a stationary baffle located approximately four (4) feet (1.2m) from the end of the tank receiving the discharge from the interceptor. This baffle shall extend the width of the tank and to within four (4) inches (100mm) of the bottom of the tank. The purpose of this baffle is to limit the heavy spread of grease to one end of the tank and to control to a degree the turbulent water currents created by the flow from the interceptor. The dimensions of the tank shall be approximately twelve (12) feet (3.6m) in length, thirty six (36) inches (0.9m) in width, and two (2) feet (0.80m) in depth. The tank shall be constructed of stainless steel sheet metal with steel angle rim and reinforcement. The waste outlet from the tank is to be four (4) inches (100mm) in diameter, connected to the bottom of the tank at one end and trapped to retain approximately eighteen (18) inches (0.46m) of water in the tank. The tank is also provided with a four (4) inch (100mm) bottom drain to permit draining and cleaning.



INSTALLATION OF TESTING EQUIPMENT

4.1 Sink Location

The sink is to be located on an upper floor with the sink rim three (3) feet (0.91m) above that floor level.

4.2 Interceptor Location

The grease interceptor shall be so located that its bottom is ten (10) feet (3.05m) below the floor level upon which the sink is located. The interceptor shall be equipped with a water-tight and airtight cover. During the test there shall be no signs of leakage from the cover as supplied by the manufacturer. Note for Grease removal devices (GRD) the grease removal function shall be disabled.

4.3 Skimming Tank Location

The skimming tank shall be located low enough, with respect to the interceptor, for the discharge piping from the interceptor to clear the tank rim by not less than three (3) inches (76mm).

4.4 Installation of Waste Piping

4.4.1 Sink Connections

The sink outlet waste connection from each sink compartment is to be one and one-half (1½) inches (38mm) in size for 4 GPM to 50 GPM interceptor sizes and two (2) inch diameter for 75 GPM/100 GPM. Each connection shall be fitted with a quick opening gate valve.

4.4.2 Combined Horizontal Waste Piping

The combined horizontal waste piping into which the sink outlets connect shall be two (2) inches (50mm) in size, installed with the center line eleven (11) inches (0.28m) below the bottom of the sink and properly hung and braced from the sink reinforcement and supports. This waste pipe shall be fitted to the inlet of a vented flow control or equal device.

4.4.3 Vented Flow Control Device

The flow control device is to be adequate in size for the interceptor tested and shall be equipped with the proper size orifice and/or other details to provide the proposed flow rate of the subject interceptor, based on the simultaneous drainage of both sink compartments as detailed hereinafter. The vent from the flow control shall extend above the flood rim of the sink.

4.4.4 Vertical Waste Riser

The vertical waste riser shall be connected to the outlet of the flow control device and shall extend downward to connect to the interceptor inlet by means of an elbow and a short horizontal nipple. The size of the riser pipe and elbow shall be two (2) inches for testing 4 GPM to 50 GPM and three (3) inches for 75 GPM/100 GPM interceptor size testing.

4.4.5 Interceptor Discharge Connection

The discharge pipe from the interceptor outlet to the skimming tank shall be equal to the outlet connection of the interceptor with a minimum pitch of one-eighth (1/8) inch per foot (1cm per m) and shall be provided with a two (2) inch (50mm) vent properly located to prevent siphoning of the interceptor.

4.4.6 Interceptor Inlet Connections

If the inlet diameter of the interceptor to be tested exceeds the riser pipe diameter size, use reducing couplings to permit connections of the inlet and discharge pipes.

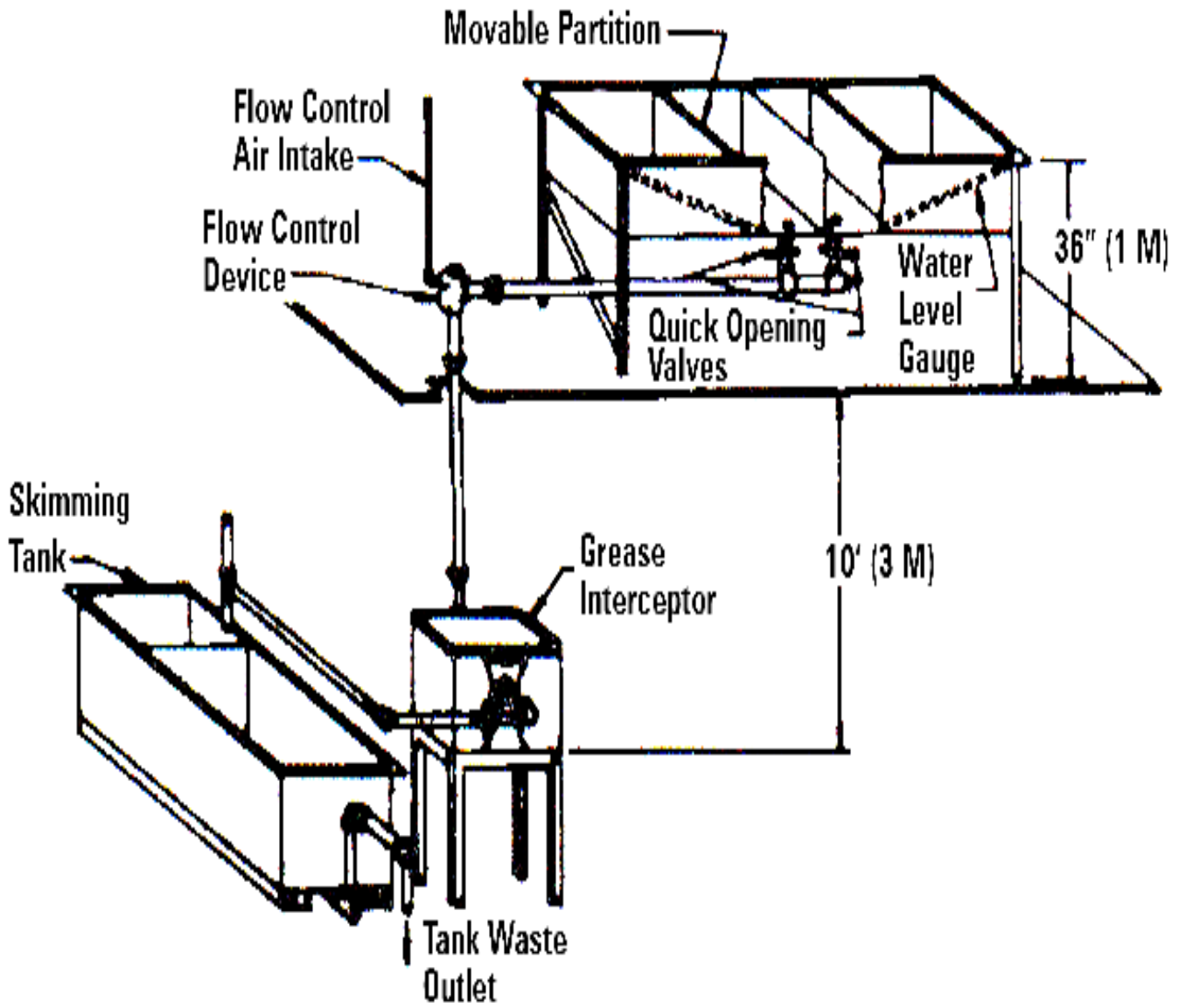

Figure 1



PRELIMINARY TEST PROCEDURES

5.1 Media Analysis

Before conducting certification tests on any interceptor, simple analysis of the test media are to be made to determine the following characteristics:

- (a) Water-Hydrogen ion concentration (pH value).
- (b) Lard-Specific gravity, at one hundred and fifty (150) degrees Fahrenheit (65.5°C).
-Viscosity in Seconds Saybolt Universal (SSU), at one hundred and fifty (150) degrees Fahrenheit (65.5° C).

5.2 Establishing Sink Compartment Capacity

The size of each test compartment shall be established by means of the movable partitions so that the gross capacity of each compartment in gallons will be equal to one and two-tenths (1.2) times the proposed flow rate in gallons per minute (GPM) of the interceptor to be tested. The gross sink capacity mentioned above is to be calculated on the basis of twelve (12) inches (0.3m) above the sink outlet flange.

5.3 Establishing Volume of Incremental Discharge

The volume of water to be discharged from each sink compartment during each test increment shall be based on ten (10) inches (0.25m) of water above the sink outlet flange. On this basis the incremental discharge in gallons per compartment will be equal to the proposed gallons per minute (GPM) flow rate of the interceptor being tested.

5.4 Computation of Flow Rate

The flow rate from the sink shall be computed by timing the rate of drainage of the first nine and one-half (9½) inches (0.24m) of water from the sink compartment, measured from the ten (10) inch (0.25m) mark to the datum line one-half (½) inch (13mm) above the sink outlet flange.

5.4.1 Check Flow Rate Tests

After the sink compartment capacities have been established, the sink waste piping connected to the interceptor with the flow control or equivalent device properly sized and installed, and the interceptor discharge pipe properly vented and extended to the skimming tank, a series of check flow rate tests are to be made. Three (3) tests are to be made for each of the following four (4) conditions: (During test groups (a) and (b) the waste outlet from the adjacent compartment shall be closed off.)

- (a) Drain, gauge and compute the flow rate from compartment #1 separately.
- (b) Drain, gauge and compute the flow rate from compartment #2 separately.

Flow rates determined in (a) and (b) are only for purposes of checking against actual flow rates of test increments.

- (c) Drain compartments #1 and #2 simultaneously and gauge and compute the flow rate on the basis of the time required to drain compartment #1.
- (d) Drain compartments #1 and #2 simultaneously and gauge and compute the flow rate on the basis of the time required to drain compartment #2.



5.4.2 Calibrated Drainage Flow Rates

The average of the three (3) tests for each of groups (c) and (d) above shall be considered as the calibrated drainage flow rate for that group provided no one of the tests varies by more than five (5) percent from the other two in the same group. If such variation occurs, the test showing the discrepancy shall be discarded and additional check tests shall be made until three (3) tests meeting the above condition are obtained. The average of the calibrated drainage flow rates for simultaneous discharge, as determined in Sections 5.4.1 (c), 5.4.1 (d), and 5.4.2 must be equal to or exceed by not more than five (5) percent the proposed flow rate of the interceptor being tested.

If the average flow rate so determined is less than the proposed flow rate of the interceptor, the flow control orifice is to be enlarged and the check flow rate tests rerun and the calibrated drainage flow rates again computed until flow rates within the required limits are obtained.

If the average of the calibrated drainage flow rates exceeds the proposed flow rate of the interceptor by more than five (5) percent, the flow control orifice shall be reduced in size and the above tests shall be repeated until an average flow rate is obtained which falls within the five (5) percent limit stipulated above.



SKIMMING PROCEDURE

The skimming procedure is to be initiated approximately five (5) minutes after the increment to be skimmed has discharged into the tank. A sheet metal hand baffle, slightly shorter than the width of the skimming tank and approximately one (1) foot (0.30m) in width is employed to push all surfaced grease to one corner of the tank from which the layer of grease is readily skimmed by means of a rectangular pan. The mixture of water and grease thus removed is placed in a pail equipped with a drainage spigot. All grease is squeegeed from the baffle and pan. This process is continued until most of the visible grease has been removed from the surface of the water in the skim tank.

- 6.1** At this point, while the hand baffle previously used is allowed to cool, a second hand baffle is employed in the following manner. The first inch (25mm) of the baffle plate is immersed at one end of the skimming tank and the baffle moved toward the opposite end, as before, to concentrate the thin film of surfaced grease. The baffle is moved slow enough to prevent turbulence from drawing the accumulating grease below the baffle, and fast enough so that minimum grease will pass through the clearance space between the baffle and the tank walls. Upon reaching a point about two (2) inches (50mm) from the end of the tank, the baffle motion is slowed and, at the same time, the baffle is lowered to bring the cooler surface in contact with the trapped grease. These motions are so regulated as to have the baffle submerged to within an inch (25mm) of its top by the time it reaches the end of the last two (2) inches (50mm) of horizontal travel. The baffle is then removed from the water and moved grease side up, to the pail where the adhering grease is squeegeed off and added to the previous contents. By now, the first baffle has cooled, and the above procedure is repeated using it. The baffles are used alternately until the amount of grease collected is negligible.
- 6.2** Upon completion of the above skimming procedures, the water is drained from the bottom of the pail by means of the spigot. The pail is then placed over a gas flame and its contents heated until the residual water is brought to boiling temperature; that is, until bubbles of steam rise through the molten grease. The mixture is then poured from the pail into a separatory funnel, the pail is squeegeed out and the mixture is allowed to stand in the funnel for approximately five (5) minutes, at the end of which time the water is drawn off from the bottom of the funnel. The remaining liquid is permitted to separate for approximately five (5) more minutes and the water is again removed from the bottom of the funnel. The remainder is drained from the separatory funnel into one or more pre-weighed cans.
 - 6.2.1** These cans are placed in a deep freeze unit or other suitable cool location and the grease is permitted to solidify. The solidified contents are then scraped and kneaded with a small putty knife and the water thus worked from the mixture is poured off. If the quantity of water thus removed is greater than several drops, the heating and solidification process is repeated. When only a few drops of water are removed in this manner, the mixture is assumed to be completely dewatered and weights are taken for computation purposes.
 - 6.2.2** Weighing is done on a gram balance and weights are taken to the nearest one-half ($\frac{1}{2}$) gram (0.0011 lb.). Tare weights of the pre-weighed cans are subtracted from the total weight and the correct weight entered as data.

CERTIFICATION TEST PROCEDURE

7.1 Test Media

Certification tests shall be conducted with fresh, unused Swift & Company Prime Steam Lard or equal and water, both within a temperature range of from one hundred-fifty (150) to one hundred-sixty (160) degrees Fahrenheit (65.5° to 71°C).

7.2 Ratio of Lard to Water

Both compartments of the test sink shall be supplied with the required volume of water (Sec. 5.2 and 5.3) at the temperature stipulated in 7.1. The test lard shall be introduced into one compartment, during each incremental discharge, in the ratio of one (1) pound (0.45kg) of lard for each five (5) gallons (19L) of water in that compartment. Consequently, the proportion of lard to the total amount of water discharged from both sink compartments during each increment will be one (1) pound (0.45kg) for each ten (10) gallons (39L). The required amount of test lard, within the above temperature range, shall be weighed out and poured into the test compartment of the sink.

7.3 Test Increments

Each test increment shall consist of the simultaneous discharge of the water from both sink compartments and the lard from the test compartment.

- 7.3.1** During the first test increment the lard shall be poured into the No.1 compartment (that compartment having its discharge outlet closest to the interceptor, measured along the waste pipe) and the No. 2 compartment shall discharge clear water. During the second test increment the lard shall be poured into the No. 2 compartment while the water in No.1 compartment remains clear. This procedure of introducing the lard into alternate sink compartments shall be continued throughout the test.

7.4 Flow Rates

The drainage period for each increment is to be gauged and timed on the basis of the flow from the compartment containing the clear water. The flow rate from the sink is to be computed and recorded for each increment.

7.5 Efficiency Determinations

The grease shall be removed from the skimming tank and the efficiency of the interceptor shall be computed at intervals of five (5) increments or less until the average efficiency reaches approximately ninety-three (93) percent and/or the incremental efficiency reaches approximately eighty-five (85) percent. After this point has been reached, efficiency checks shall be made after each incremental discharge.

7.6 Duration of the Test

The above test procedure is to be continued until the average efficiency reaches eighty-five (85) percent or less, and/or the incremental efficiency reaches seventy-five (75) percent or less.

7.7 Determination of Test Breakdown Point

The test failure, or breakdown point of the interceptor, shall be established at the increment preceding two (2) successive increments in which either the average efficiency is less than ninety (90) percent or the incremental efficiency is less than eighty (80) percent. The formula for determining the above efficiency shall be as follows:

$$\text{Efficiency} = \frac{\text{Grease Added} - \text{Grease Skimmed}}{\text{Grease added}}$$

7.8 Requirements for Certification and Factor of Safety

To receive certification in accordance with the Plumbing and Drainage Institute Standard Testing Procedure for Grease Interceptors, the interceptor shall conform with or exceed the following requirements at the breakdown point:

- a) Have an average efficiency of ninety (90) percent or more (See Section 7.7) at the rated grease retention capacity to flow rate, as indicated in Table 1
- b) Have an incremental efficiency of eighty (80) percent or more. (See Section 7.7)
- c) Have a minimum grease capacity per Table 1, having retained not less than two and one-quarter (2¼) pounds (1 kg) of grease for each one (1) gallon per minute (GPM) (3.8 L/min) average flow rate as determined during the test. Retained grease is total grease added less total grease skimmed at the breakdown point. (This provides at least a twelve and one-half (12.5) percent safety factor on the ratio of the rated grease retention capacity to flow rate, as indicated in the following Table 1.)

7.9 Certification Capacities

Standard certification flow rate and grease retention capacities for grease interceptors tested in accordance with the above procedure shall conform to the following:

TABLE 1

PDI Size Symbol	4	7	10	15	20	25	35	50	75	100
Flow Rate GPM	4	7	10	15	20	25	35	50	75	100
L/min	15	26	38	57	77	95	132	191	230	378
Grease Capacity										
Pounds	8	14	20	30	40	50	70	100	150	200
Kg	3.6	6.4	9.1	13.8	18.2	22.7	31.8	45.4	68	90.8



SIZING FOR GREASE INTERCEPTORS

Realizing the need for uniform sizing, installation and maintenance data for Plumbing and Drainage Institute certified grease interceptors conforming to the testing and rating procedures outlined in Standard PDI-G101, it was deemed advisable to cover this information. The recommendations for sizing, installation and maintenance of grease interceptors contained herein are based on experience of the Industry.

8.0 Sizing Considerations

- 8.1.1 A grease interceptor conforming to Standard PDI-G101 is designed and certified to operate efficiently at its maximum flow rate in GPM. and retain a minimum of twice its rated GPM in lbs of grease. The larger the interceptor the higher the flow rate it will handle efficiently with a greater quantity of grease retained before cleaning is required. While a small interceptor, undersized, can accommodate a flow of waste water well in excess of its rated capacity, it will not intercept grease efficiently under such overload conditions.
- 8.1.2 Fixture drainage period in combination with the service required and the quantity of waste water involved, establishes the rate of flow through the grease interceptor. Flow rate is therefore the primary gauge; and flow rate establishes interceptor size or capacity.
- 8.1.3 The link between flow rate and installation to produce satisfactory grease interceptor operation is a Flow Control Fitting. A correctly sized grease interceptor will not regulate the flow of water discharged from the fixture it is serving. Therefore, to ensure that the flow rate does not exceed the grease interceptor's rated capacity, a Flow Control Fitting is required. The Flow Control Fitting is essential for protection against overloading the grease interceptor which could otherwise occur from sudden surges from the fixture. The Flow Control Fitting will control the flow of waste water at all times, enabling the interceptor to operate at its certified capacity.

8.2 Size Symbols

It has been determined through the testing and rating procedure that ten (10) different sized grease interceptors are required for various installations. These sizes are based on certification standard flow rates and grease retention capacity ratings for grease interceptors. Table 1 lists the PDI size symbol for each of the standard rated grease interceptors.

8.3 Sizing Procedure

8.3.1 Sizing Method Based on Pipe Diameter Size and Slope

When the final configuration of fixtures in a facility is not known or to allow for additional fixtures in the future, this method shall be used or to size the interceptor for the maximum flow that the drain line from the facility can carry.

Pipe Size (inches)	Full Pipe Flow @ ¼ slope	Interceptor size 1 minute drain	Interceptor size 2 minute drain
2"	19.44 gpm	20 gpm	10 gpm
3"	58.67 gpm.	75 gpm	35 gpm
4"	125.77 gpm	-	75 gpm

8.3.2 Procedure for Sizing Grease Interceptors

Table 8.3.2 is provided to show the standard formula in steps for sizing grease interceptors to suit requirements of specific fixtures. An example of this sizing formula application is included to illustrate the steps.

Table 8.3.2
Procedure for Sizing Grease Interceptors

Steps	Formula	Example
1	Determine cubic content of fixture. Multiply length x width x depth.	A sink 48" long by 24" wide by 12" deep. Cubic content $48 \times 24 \times 12 = 13,824$ cubic inches.
2	Determine capacity in gallons. 1 gal. = 231 cubic inches.	Content in gallons. $\frac{13,824}{231} = 59.8$ gallons
3	Determine actual drainage load. The fixture is normally filled to about 75% of capacity with water. The items been washed displace about 25% of the fixture content, thus actual drainage load = 75% of fixture capacity.	Actual drainage load $.75 \times 59.8 = 44.9$ gallons.
4	In general, good practice dictates a 1 minute drainage period: however, where conditions permit, a 2 minute drainage period is acceptable. Drainage period is the actual time required to completely drain the fixture. Flow rate = $\frac{\text{Actual Drainage Load}}{\text{Drainage Period}}$	Calculate flow rate and drainage period 1-minute period $\frac{44.9}{1} = 44.9$ GPM Flow Rate 2-minute period $\frac{44.9}{2} = 22.5$ GPM Flow Rate
5	From Table 8.2 select Interceptor which corresponds to the flow rate calculated. Note: Select next larger size when flow rate falls between two sizes listed.	Select Interceptor. For 1-minute period - 44.9 GPM requires PDI size 50. For 2-minute period - 22.5 GPM requires PDI size 25.

8.3.3 Sizing by known compartment sizing

Table 8.3.3 is included as a selection chart for standard PDI Certified grease interceptors applicable to various size fixtures commonly used in domestic, commercial and institutional installations. The selections listed are based on the sizing formula covered in Table 8.3.2 by GPM.

Table 8.3.3
Selection Chart (Metric Equivalents Omitted for Simplicity)

Fixture Compartment Size (inches)	Number of Compartments	Drainage Load (Gallons)	Recommended PDI Size Grease Interceptor	
			1-minute Drainage period	2-minute Drainage period
18 x 12 x 8	1	4.2	7	4
16 x 14 x 8	1	5.8	7	4
20 x 18 x 8	1	9.4	10	7
18 x 18 x 8	2	15.0	15	10
20 x 18 x 8	2	18.7	20	10
30 x 20 x 8	1	15.5	20	10
24 x 20 x 12	1	18.7	20	10
22 x 20 x 1	2	23.0	25	15
22 x 20 x 12	2	34.0	35	20
24 x 24 x 12	2	44.9	50	25
(2) 22 x 20 x 12	4	68.0	75	50
(2) 24 x 24 x 12	4	89.8	100	75

8.4 Dishwashers

A separate grease interceptor is recommended for each commercial dishwasher. The size of the interceptor is determined by the GPM discharge rate of the dishwasher as specified by the manufacturer. Select proper interceptor of equivalent or next higher rate from Table 8.2.

8.5 Multiple Fixtures

Where multiple fixtures are served by a single Interceptor calculate the interceptor size per section 8.3.1 or, calculate the capacity of each fixture and total the fixture capacities up, or establish the total capacity of the maximum number of fixtures that may be drained simultaneously. Then using the GPM capacity calculated proceed with sizing of the interceptor to the nearest PDI size, larger than the calculated capacity based on a one minute or two minute drain down time.



GREASE INTERCEPTOR CERTIFICATE AND CERTIFICATION SEAL

9.1 Certificate

A certificate is issued by the authorized testing laboratory upon successful completion of standard PDI-G101 tests for each interceptor tested.

9.2 PDI Certification Seal

Grease interceptors which are certified by the manufacturer as being identical in the relevant respects considered in PDI-G101 to the unit tested and certified as detailed herein by an independent laboratory approved by the Institute may bear the Institute's Certification Seal as exemplified below, provided such manufacturer also executes the Institute's current Standard Certification Mark License Agreement.



9.2.1 Marking

The PDI nameplate shall be permanently marked with the manufacturer's name, the PDI symbol rating and the minimum grease retention capacity in lbs or the actual retained grease. The interceptor shall have the inlet and outlet identified.





Installation

10.1 Installation Considerations

- 10.1.1 Install interceptor as close as practical to fixture or fixtures being served, PDI recommends not to exceed twenty-five (25) feet. The interceptor may be set on the floor, partially recessed in the floor, with top flush with the floor, or fully recessed below the floor to suit piping and structural conditions.
- 10.1.2 Anticipate sufficient clearance for removal of interceptor cover for cleaning.
- 10.1.3 Avoid installation wherein long runs of pipe (exceeding twenty-five (25) feet) are necessary to reach interceptor. This precaution will preclude the possibility of pipeline becoming clogged with congealed grease that will collect before reaching the grease interceptor.
- 10.1.4 Do not install grease interceptor in waste line from garbage grinder. Garbage grinder waste shall bypass interceptor. Rapid accumulation of solid matter will greatly reduce grease interceptor efficiency preventing operation in compliance with rated capacity.

10.2 Vented Flow Control

- 10.2.1 The flow control fitting furnished with PDI certified interceptors must be installed prior to the grease interceptor in the waste line beyond the last connection from the fixture and as close as possible to the underside of lowest fixture. When waste of two or more sinks or fixtures are combined to be served by one interceptor, a single flow control fitting should be used. If the drain line drops ten (10) feet or more to the interceptor, check with the manufacturer to see if an additional flow control is needed due to built up head pressures.
- 10.2.2 Air intake for flow control shall terminate six (6) inches above the flood rim of the sink, terminate in a return bend at the same height and on outside of building, or be re-vented into the vent system of the building per local plumbing codes. (See A1.5) When fixture is individually trapped and back vented, air intake may intersect vent stack. All installation recommendations shall be subject to approval of code authority.

10.3 Venting

Grease interceptors shall have a vented waste on the outlet side, sized in accordance with code requirements for venting traps to retain water seal and prevent siphoning.

10.4 Multiple Fixture Installation

One interceptor to serve multiple fixtures is recommended only where fixtures are located close together. In such installations, each fixture should be individually trapped and back vented.

APPENDIX

A1.5 Installation Diagrams

Figures A1.5.1 through A1.5.5 are included to illustrate various grease interceptor installations normally encountered in domestic, commercial and institutional systems. These figures will serve as a guide to practical application of grease interceptors.

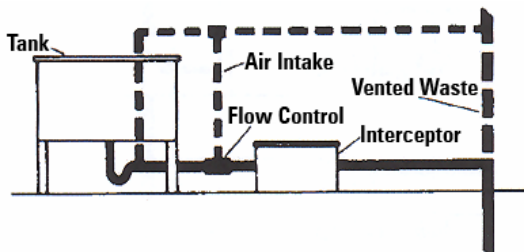

Figure A1.5.1- Interceptor Serving Trapped & Vented Sink-Flow Control Air Intake Intersects Vent

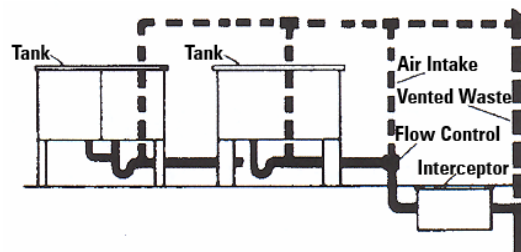

Figure A1.5.4- Interceptor Serving Two Individually Trapped & Vented Sinks-Flow Control Air Intake Intersects Vent

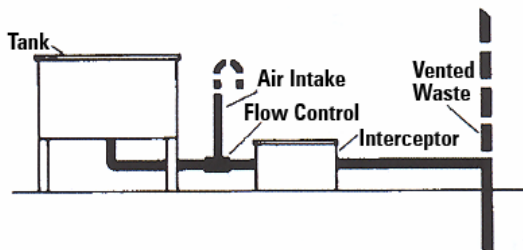

Figure A1.5.2- Interceptor Serving Sink-Flow Control Air Intake Terminates in a Return Bend Above Flood Level

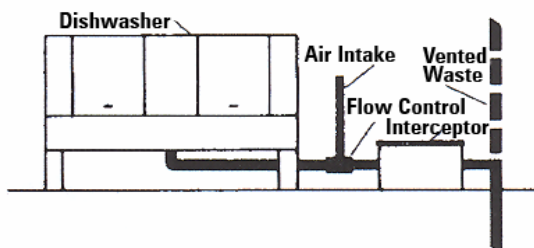

Figure A1.5.3- Interceptor Serving Dishwasher-Flow Control Air Intake Terminates Above Flood Level

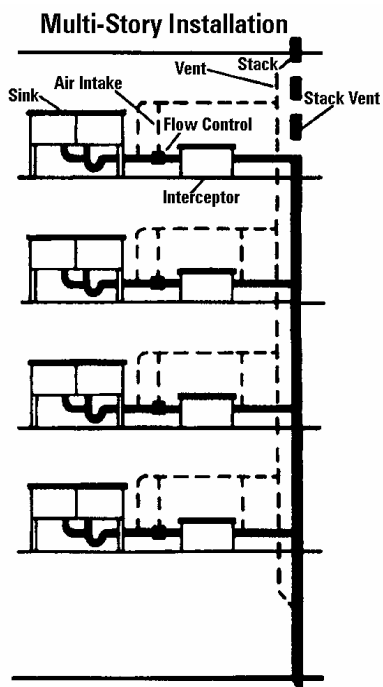
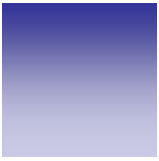

Figure A1.5.5- Interceptors Serving Trapped & Vented Sinks-Flow Control Air Intakes Intersect Vent



A2. Maintenance

A2.1 General Considerations

To obtain optimum operating efficiency of a properly sized and installed PDI certified grease interceptor, a regular schedule of maintenance shall be adhered to. All PDI certified grease interceptors are furnished with manufacturer's operating and maintenance instructions, which shall be followed to insure efficient satisfactory operation.

A2.2 Cleaning

All grease interceptors must be cleaned regularly. The frequency of grease removal is dependent upon the capacity of the interceptor and the quantity of grease in the waste water. Grease removal intervals may therefore vary from once a week to once in several weeks. When the grease removal interval has been determined for a specific installation, regular cleaning at that interval is necessary to maintain the rated efficiency of the interceptor. After the accumulated grease and waste material has been removed, the interceptor should be thoroughly checked to make certain that inlet, outlet and air relief ports are clear of obstructions.

A2.3 Disposition of Intercepted Materials

Grease and other waste matter that has been removed from the interceptor should not be introduced into any drain, sewer, or natural body of water. This waste matter should be placed in proper containers for disposal. Where recovery of grease is desired, it can be handled in a manner suitable to the authorities.